

Axiovert 200

The New Standard in Inverted Microscopy

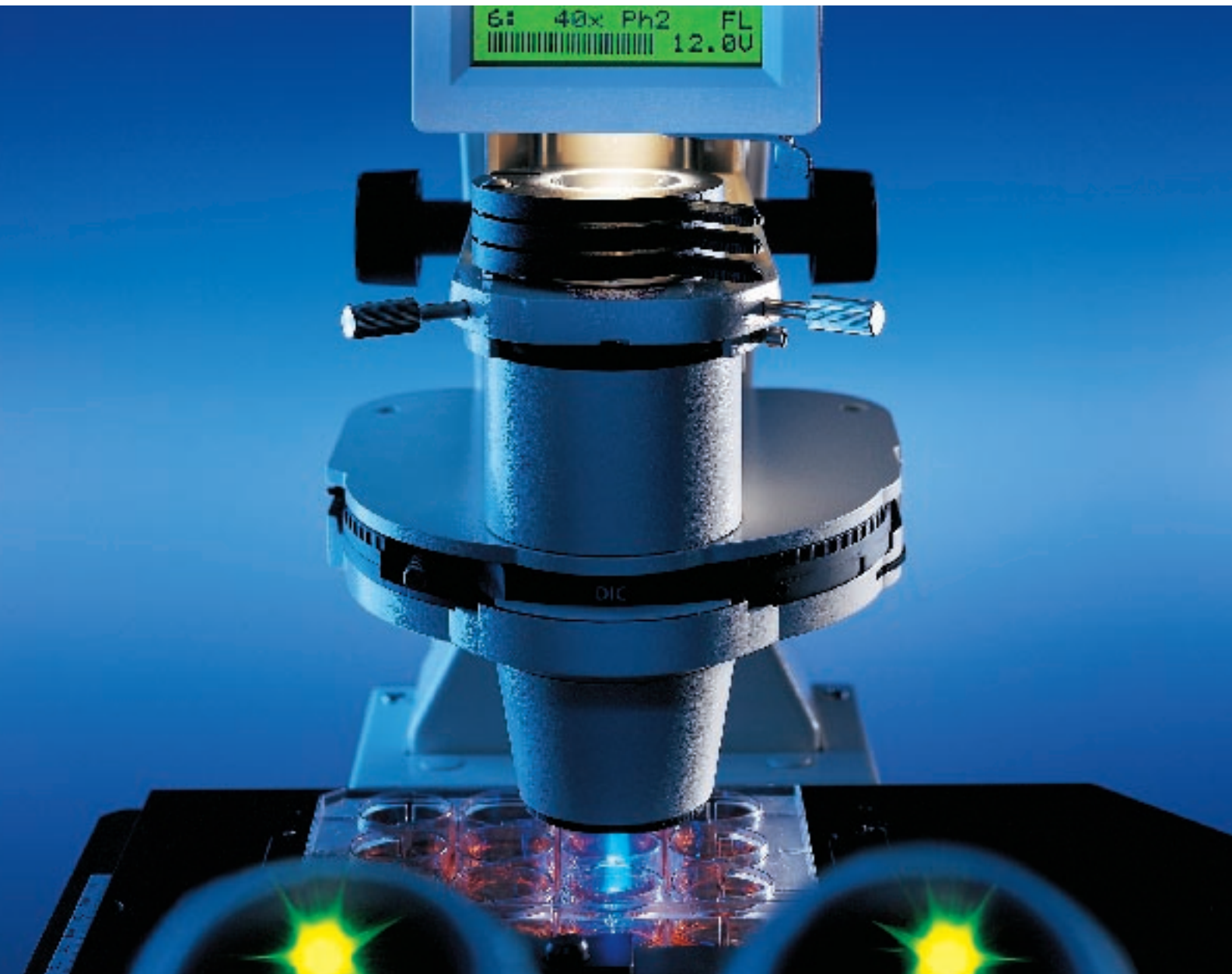

**If you need the best,
there is simply no alternative**



Axiovert 200

The New Breakthrough for Research and Routine

Unique in Every Detail

Live cell imaging, micromanipulation in living cells – never before have such rigorous demands been placed on the stability, flexibility, reliability and operating comfort of microscopes. And never before has there been a microscope capable of meeting these demands with such ease and elegance: Its name: **Axiovert 200**, the state of the art in inverted microscopy from Zeiss.

Axiovert 200 is based on the extraordinary expertise of a company which has been setting international standards in inverted microscopy since 1924, the first microscope with infinity optics. But above all, this research inverted microscope surpasses earlier models in every crucial detail: the outstanding Zeiss optics with the wide range of ICS objectives, with innovative condensers and optimized fluorescence as well as with an unusual scope of sophisticated documentation and adaptation options, outstanding stability and unique ergonomical design. And **Axiovert 200 M**, fully motorized, gives you the freedom to automate many procedures – so you save time with no loss in reliability.

Axiovert 200 is much more than the sum of its benefits. Why? Because it gives you a powerful platform to carry out your research in all life science applications more precisely, more rapidly and more successfully than before. In other words: it gives you the platform that ensures you're in the lead. And that's exactly where you need to be in science today.

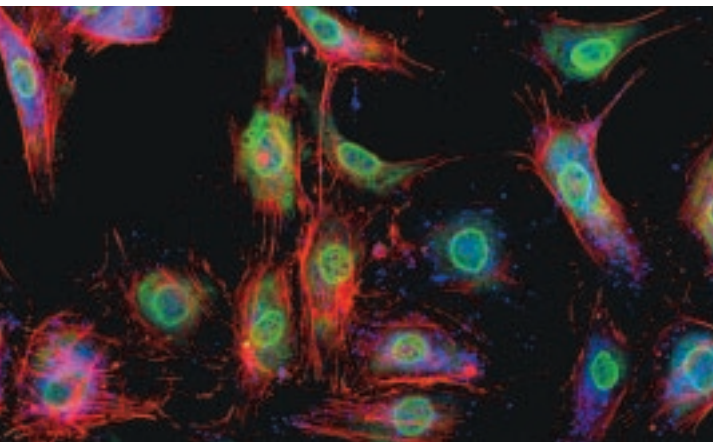

*Endothelial cells,
J. Zbären, Inselspital, Bern*



*For every application
the right objective:
ICS optics – only limited
by the laws of physics*

Axiovert 200

Innovations You Need for Success: The New Features

A+ for Stability and Flexibility:

The New Stand

Open for all individual solutions – **Axiovert 200** forms the basis for all special tasks: the stand with unmatched flexibility of optical, mechanical and electronic interfaces. This gives you new freedom in your work. You choose the system best suited for the application. And it doesn't matter if you use Zeiss components or accessories from other reputable manufacturers.

A convincing example of this diversity: the possibilities for documentation. Inclusive of the dual video adapter you now have up to six camera interfaces. And all of this combined with an unprecedented stability.

By Contrast the Best:

The New Fluorescence

We haven't reinvented fluorescence. But we have improved it substantially. Results with a visible difference: much more contrast and much

less stray light. In other words: with an unprecedented signal to noise ratio – made possible by the patented Zeiss Light Trap. And that's not all. Sophisticated features such as the motorized shutter that protects the specimen and the easily accessible diaphragm planes with interchangeable aperture and field stop slider. They provide full Köhler illumination in fluorescence, thereby further improving image quality. And one more attractive feature: a total of five filter positions with full 23 mm visual field. Can be exchanged in seconds. Just push & click.

More Comfort, Convenience and Control: The New Ergonomics

Easy to use with a focus on operating comfort: **Axiovert 200** provides excellence in ergonomical design:

- All controls – from lamp voltage to baseport slider – are conveniently arranged close to the focusing knobs.
- The Ergo tube with ideal viewing angle, adjustable for every height.
- The LCD display at eye level so that all important functions are easily visible.
- Many practical innovations which make your work easier, such as Light Manager and Focus Stop or the Sénarmont DIC slider.

But all these ergonomical benefits can only really be appreciated in your daily work.

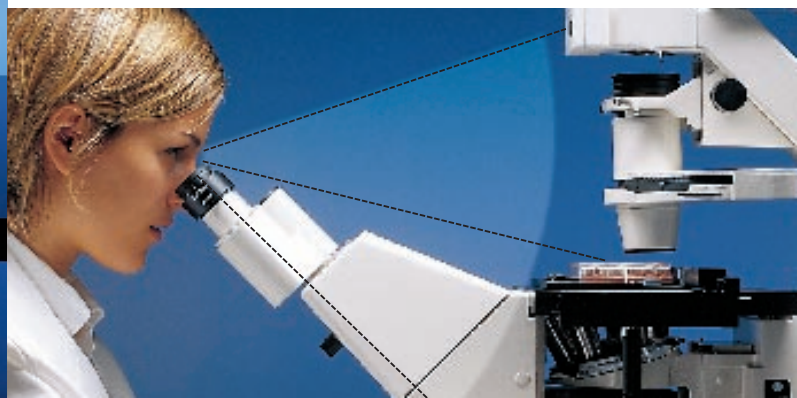
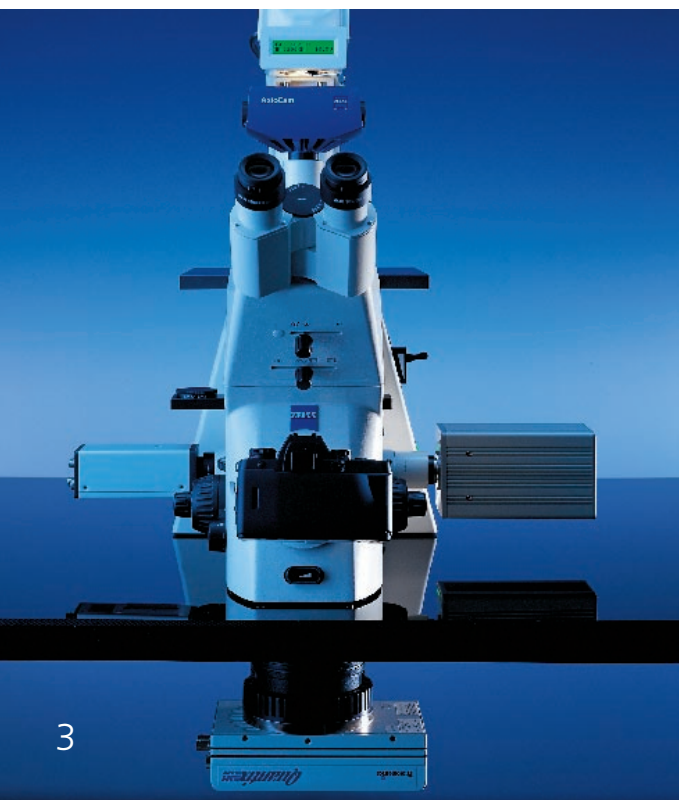

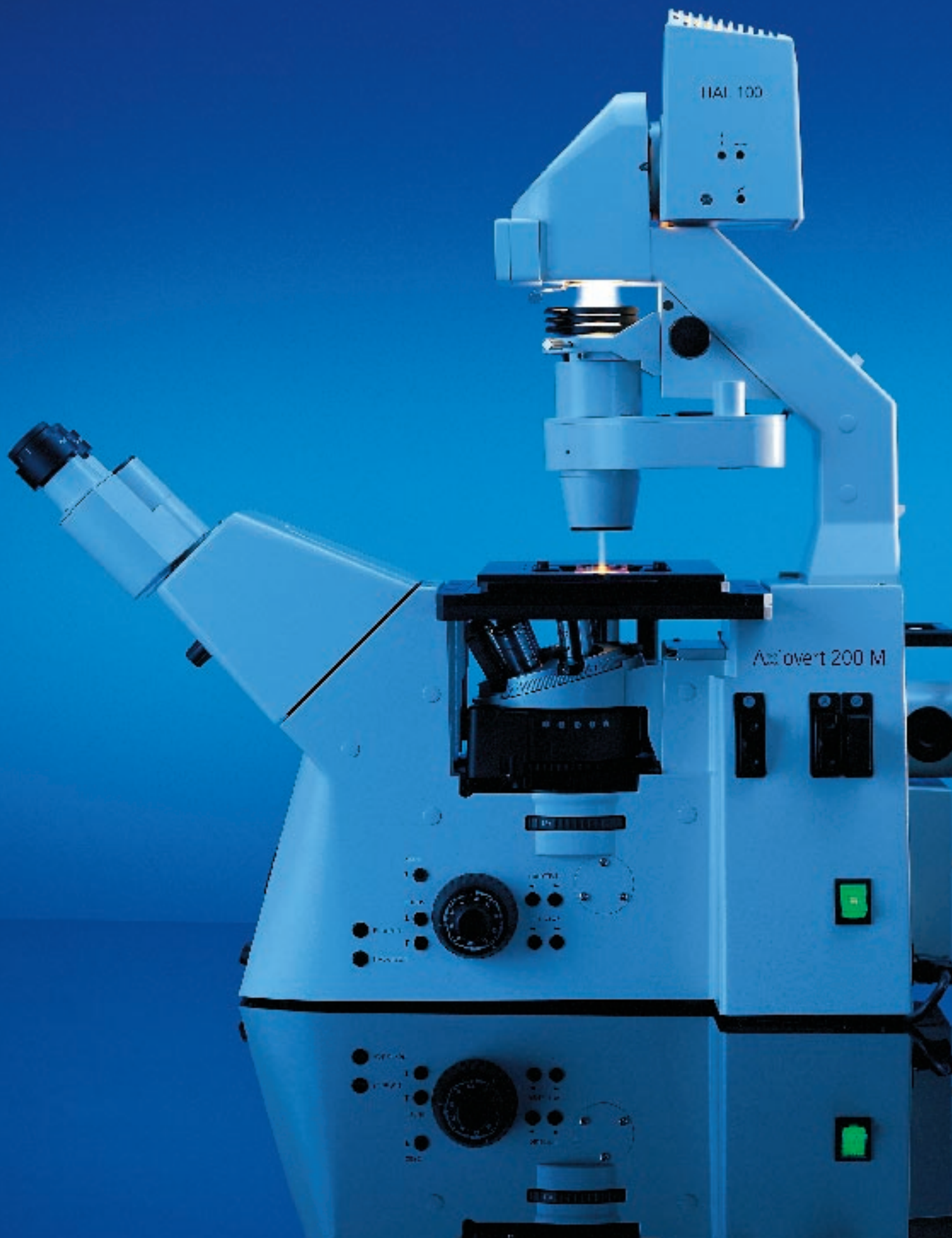

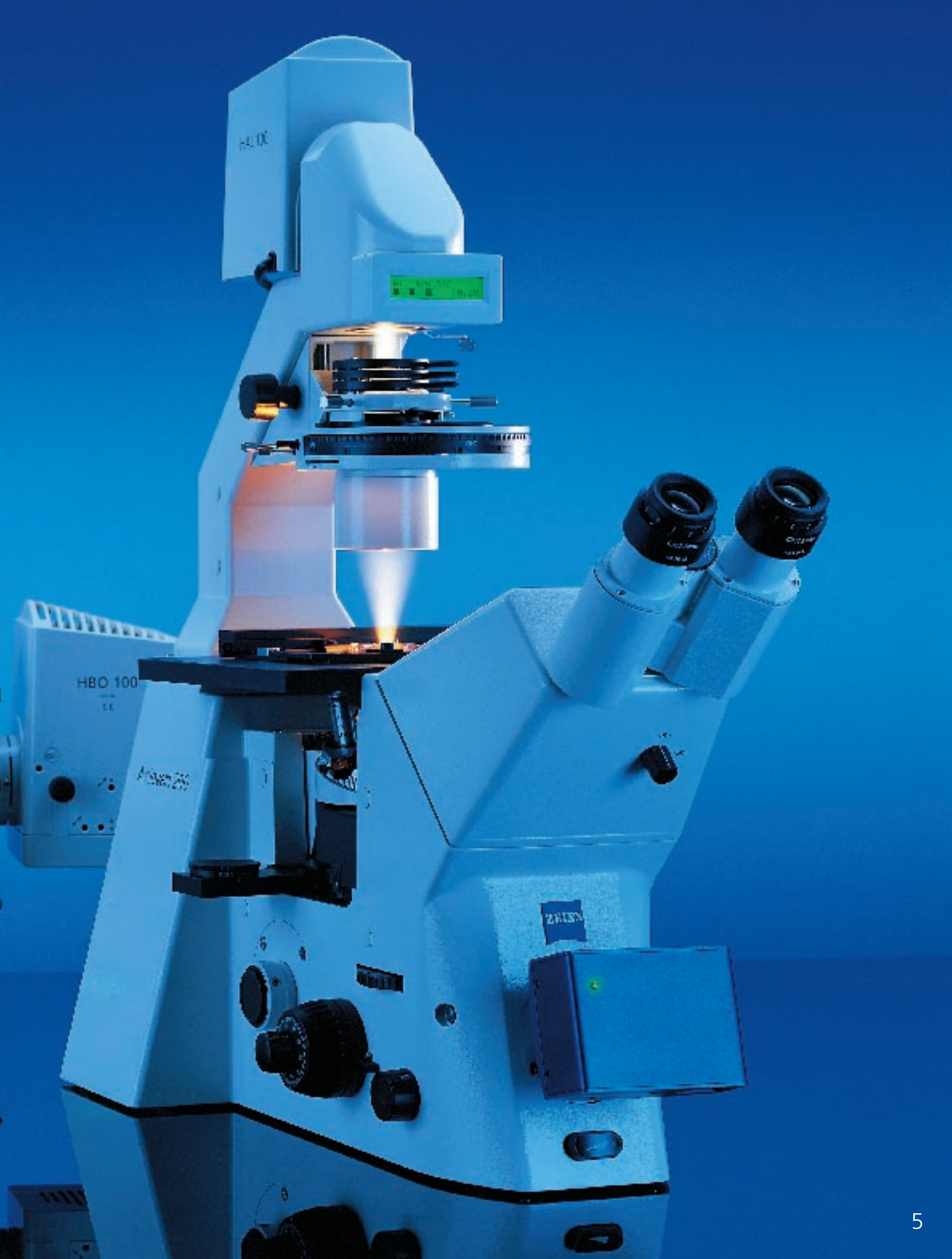



**Powerful Protection:
The New Aqua Stop**

The idea is simple, the performance powerful: Aqua Stop, the latest Zeiss innovation. It protects objectives and stands from any liquids that have been spilled. Through a triple protection system. First, through the silicon sealing directly on the objective. Second, through a sealing that covers the entire objective turret. And third, through a container placed under the objective turret. Two tubes drain the liquid away from the microscope. Accidents do happen, but now you have the best protection.

**More Room for Better Results:
The New Condensers**

More freedom in microscopy. On the one hand, that means much longer working distances – so important for smooth and easy manipulation, so important for keeping cell specimens in easy sight.

And on the other hand, more freedom in microscopy means greater freedom of choice among all the important contrasting techniques. The new LD condensers can be used for: DIC, Phase or Varel contrasting techniques. Quite simply the best solution for your specific demands.

*The new LD condensers.
More room for your convenience.
NA: 0.35 – WD 70 mm
NA: 0.55 – WD 26 mm
NA: 0.8 – WD 7 mm*

**Motorized and Mighty:
Axiovert 200 M**

Simplifies and speeds up complex operations: With up to eight coded/motorized components, **Axiovert 200 M** provides the best platform for the automation of live cell imaging applications:

- Automatic adjustment of objective and reflector turret
- Automatic setting of previously selected diaphragms and brightness levels via Light Manager
- Choice of five documentation ports via the Electronic Port System (EPS)
- Secondary 1.6x and 2.5x magnification through motorized Optovar system
- Push button controlled fluorescence and halogen lamp shutters
- Z focus with the high-precision Harmonic Drive DC motor provides a 25 nm minimum step size over a full 10 mm of travel, making it ideally suited for Deconvolution, 6D Imaging and Confocal Imaging with LSM 510 or LSM 5 PASCAL.

With **Axiovert 200 M** even complex operations can be easily carried out – either by using controls on the stand itself or AxioVisionControl software via PC.

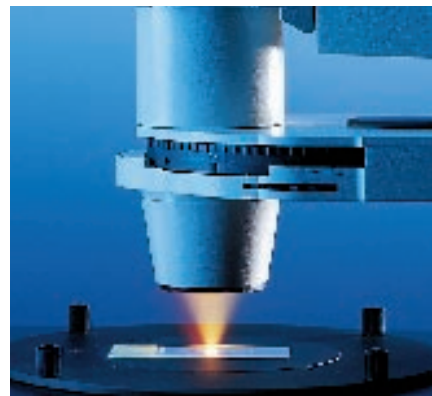
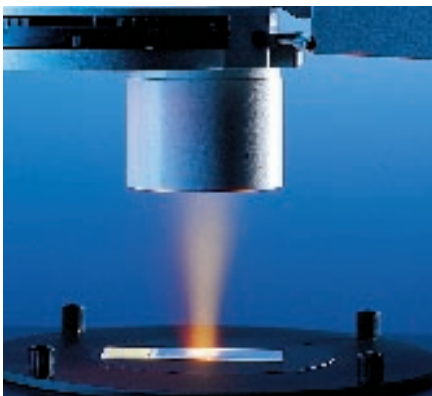

**A Superb Player
for Every Application**

Gene expression, in vitro fertilization, microdissection, 2nd-messenger processes, signal transduction, functional morphology, GFP, patch clamping: the number of applications in research and routine is mindboggling. And each of them places its own specific demands on the system's performance. **Axiovert 200** or **Axiovert 200 M** provides the basis for all research or routine workstations. No matter how specialized they are. The result is always a superbly integrated system. Right up to the cell observer, the high-end solution for live cell imaging from Zeiss. The cell observer is the unparalleled complete solution for observing and documenting living cells up to the sixth dimension.

A system of first-class components:

- Cell Observer, the new AxioVision software module for digital documentation of multidimensional time-resolved images
- AxioCam, the digital camera from Carl Zeiss, guarantees brilliant images resolved up to 3900 x 3000 pixels
- Incubators and heating stages keep your cell specimens always at just the right physiological environment
- Aqua Stop, a new Zeiss product to protect objectives and stands from any liquids that have been spilled.

*Triple labeled CHO cell
(Rhodamine, FITC, DAPI).*

*Bottom left part:
after image acquisition;*

*top right part:
after 3D deconvolution.*

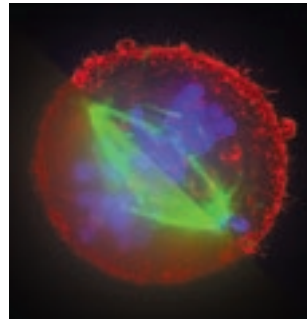

*System solution
for digital Live Cell-Imaging using
physiological conditions.*



Axiovert 200

At a glance

Platform

- 2 stands – Axiovert 200 and Axiovert 200 M
- Manual stand with coded objective turret
- Motorized stand with z motor with minimum 25 nm step size
- Manual and motorized – highest precision with Harmonic Drive DC motor

Ergonomy

- Light manager
- Ergo tube
- Operating comfort
- LCD display
- Aqua Stop

Optics

- Field of view 23
- Condenser with NA 0.55 with extra large working distance = 26 mm
- Condenser with NA 0.35 and NA 0.55 with Sénarmont DIC
- 6 x H DIC objective turret
- Fluorescence-free immersion oil: Immersol 518F

Fluorescence

- Light Trap
- Motorized shutter
- 5x reflector turret
- Push&Click filter cubes
- Aperture and field stop slider
- Adjusting aid
- Atto Arc 2 with RS232 interface

Documentation

- Sideport (left and right)
- Frontport for digital, video or SLR camera
- Baseport
- Dual video adapter

Motorization

- Objective turret
- Reflector turret
- Optovar
- Selection of TV ports
- Condenser with NA 0.55
- Z focus
- Scanning stage

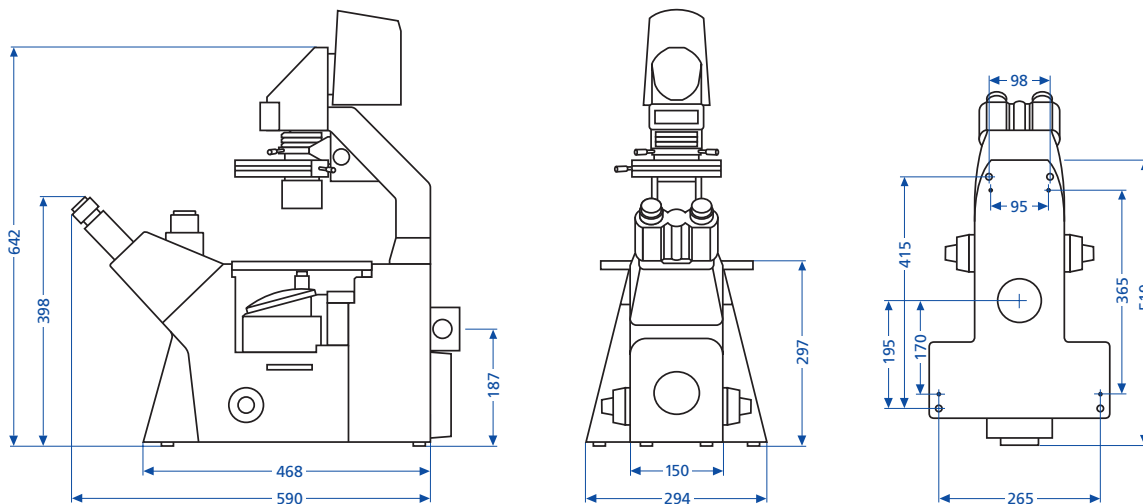

For further details, please contact:

Carl Zeiss Light Microscopy

P.O.B. 40 41
37030 Göttingen
GERMANY
Phone: ++49 5 51 50 60 660
Telefax: ++49 5 51 50 60 464
Internet: www.zeiss.de/micro
E-Mail: micro@zeiss.de

Subject to change.

*AxioCam and Light Trap are trademarks of Carl Zeiss.
Axiovert, AxioVision, LSM 5 PASCAL and Optovar are registered trademarks of Carl Zeiss.*